



NAV/GIA

Catálogo

Índice

Vertical	Pag. 5
Horizontal	Pag. 6
Gran Superficie	Pag. 7
Hormigón	Pag. 10
Encofrado	Pag. 12
Berenjeno	Pag. 14
Pavimento	Pag. 16
Guardaesquinas	Pag. 17
Doble Armadura	Pag. 18
Muro Doble	Pag. 18
Seguridad	Pag. 19
Forjado	Pag. 20
Transporte	Pag. 21
Perfil	Pag. 22
Apoyos Neopreno	Pag. 23
Tapón Tubo	Pag. 24
Vainas	Pag. 25
Calzos	Pag. 26
Alambrillo	Pag. 28
Anclaje y Elevación	Pag. 30
Aislamiento	Pag. 37
Alveolar	Pag. 37
Viga	Pag. 38
Señalización	Pag. 40
Varios	Pag. 41
Embalaje	Pag. 42
Pates	Pag. 43
Junta Dilatación	Pag. 44
Imanes	Pag. 45
Horm. Arquitectónico	Pag. 46
Perfiles	Pag. 48
Vibradores	Pag. 50
Notas	Pag. 51



Gia

	Código	Medida	Ø Hierro	Uds. Saco	Uds. Palet
	0302015	15	6/12	5.000	100.000
	0302020	20	6/12	5.000	100.000
	0302025	25	4/12	1.000	50.000
	0302026	25	8/20	1.000	30.000
	0302030	30	4/12	500	30.000
	0302032	30	8/20	500	27.000
	0302035	35	6/14	300	15.000
	0302040	40	6/14	300	15.000
	0302041	40	8/20	500	10.000
	0302050	50	6/12	200	10.000
	0302052	50	12/20	100	10.400
	0302060	60	12/20	250	9.000
	0302070	70	12/20	150	7.000
	0302075	75	12/20	125	5.250

Timón

	Código	Medida	Ø Hierro	Uds. Saco	Uds. Palet
	0301010	10	4/8	2.000	432.000
	0301015	15	4/8	2.000	216.000
	0301020	20	4/8	2.000	144.000
	0301025	25	6/12	1.000	63.000
	0301030	30	6/12	1.000	63.000
	0301040	40	6/12	500	27.000
	0301042	40	14/20	500	22.500
	0301050	50	10/18	250	11.250
	0301052	50	20/30	250	9.000

Cono

	Código	Medida	Ø Hierro	Uds. Saco	Uds. Palet
	0303225	25	6-6	1.500	30.000
	0303228	25	6-8	1.500	30.000
	0303230	30	6-6	1.500	30.000
	0303233	30	6-8	1.500	30.000
	0303235	35	6-6	1.500	30.000
	0303238	35	6-8	1.500	30.000

Gia Pilotes

	Código	Medida	Ø Hierro	Uds. Saco	Uds. Palet
	0303250	50	6/20	45	4.500
	0303275	75	6/20	45	2.205

Caballote-K

	Código	Medida	Ø Hierro	Uds. Saco	Uds. Palet
	0304115	15	5/10	2.000	144.000
	0304120	20	5/10	2.000	108.000
	0304125	25	5/10	1.000	90.000
	0304129	25	6/12	2.500	50.000
	0304128	25	6/16	3.500	21.000
	0304130	30	6/14	500	50.000
	0304135	35	6/14	1.500	50.000
	0304140	40	6/14	500	50.000
0304150	50	6/14	500	36.000	

Caballote-X

	Código	Medida	Ø Hierro	Uds. Saco	Uds. Palet
	0304415	15	6/14	1.000	162.000
	0304420	20	6/14	1.000	108.000
	0304425	25	6/14	1.000	90.000
	0304430	30	6/14	500	50.000
	0304435	35	6/14	500	50.000
	0304440	40	6/14	500	50.000

Estrella

	Código	Medida	Ø Hierro	Uds. Saco	Uds. Palet
	0380520	20	4/20	500	60.000
	0380525	25	4/20	1.000	90.000
	0380530	30	4/20	500	50.000
	0380540	40	4/20	500	30.000
	0380550	50	4/20	500	20.000

Pira

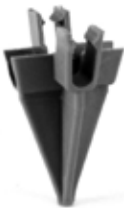
	Código	Medida	Ø Hierro	Uds. Saco	Uds. Palet
	0303110	10	5/8	1.000	154.000
	0303116	15	5/8	1.000	154.000
	0303120	20	5/8	1.000	154.000
	0303125	25	5/8	1.000	154.000
	0303130	30	5/8	1.000	100.000
	0303140	40	5/8	1.000	100.000

Caballote 4P

	Código	Medida	Ø Hierro	Uds. Saco	Uds. Palet
	0305420	20	6/20	2.000	12.000
	0305425	25	6/20	1.500	12.000
	0305430	30	6/20	1.500	12.000
	0305435	35	6/20	1.000	10.000
	0305440	40	6/20	1.000	10.000
	0305445	45	6/20	1.000	8.000
	0305450	50	6/20	500	7.500
	0305455	55	6/20	500	7.500

Multiarco

	Código	Medida	Longitud (cm)	Uds. Palet
	0370001	15	200	5.400
	0370003	20	200	5.400
	0370002	25	200	4.200
	0370000	30	200	3.600
	0370004	35	200	2.400
	0370005	40	200	2.400
	0370007	45	200	1.680
	0370006	50	200	1.680
	0370008	55	200	1.280
0370009	60	200	1.280	

Multiarco recto

	Código	Medida	Longitud (cm)	Uds. Palet
	0370110	10	200	7.000
	0370115	15	200	5.400
	0370120	20	200	5.400
	0370125	25	200	4.200
	0370130	30	200	3.600
	0370135	35	200	2.880
	0370140	40	200	2.100
	0370151	50	200	1.680

Parrilla

	Código	Medida	Uds. Palet
	0370210	10	12.000
	0370215	15	12.000
	0370220	20	10.800
	0370225	25	10.800
	0370230	30	9.000
	0370231	30	5.000
	0370235	35	5.400
	0370240	40	7.200
	0370250	50	8.640

Parrilla gancho

	Código	Medida	Uds. Palet
	0370315	15	7.200
	0370320	20	7.200
	0370325	25	7.200
	0370330	30	7.200
	0370335	35	7.200
	0370340	40	7.200

Circular

	Código	Medida	Uds. Palet
	0303010	10	3.600
	0303015	15	2.700
	0303020	20	2.500
	0303025	25	2.500
	0303042	30	1.440
	0303035	35	1.800
	0303041	40	1.500

Multirapido

	Código	Medida	Longitud (cm)	Uds. Palet
	0370920	20	100	5.750
	0370925	25	100	4.750
	0370930	30	100	4.000
	0370935	35	100	3.000
	0370940	40	100	3.000
	0370945	45	100	2.250
	0370950	50	100	2.250

Multionda

	Código	Medida	Longitud (cm)	Uds. Palet
	0370715	15	100	8.000
	0370720	20	100	8.000
	0370725	25	100	6.800
	0370730	30	100	6.000
	0370735	35	100	5.200
	0370740	40	100	4.200
	0370750	50	100	3.600

Multibarra

	Código	Medida	Longitud (cm)	Uds. Palet
	0370615	15	50	12.000
	0370620	20	50	8.400
	0370625	25	50	7.320
	0370630	30	50	6.360
	0370635	35	50	5.400
	0370640	40	50	4.800
	0370645	45	50	4.320
	0370650	50	50	2.400
	0370660	60	50	2.400

Multicurva

	Código	Medida	Longitud (cm)	Uds. Palet
	0370425	25	200	3.600
	0370430	30	200	3.000
	0370435	35	200	2.400
	0370440	40	200	2.400

Serpiente metálica

	Código	Medida	Longitud (cm)	Uds. Paq.	Uds. Palet
	0370804	40	200	25	2.000
	0370805	50	200	25	1.500
	0370806	60	200	25	1.500
	0370807	70	200	25	1.000
	0370808	80	200	25	1.000
	0370809	90	200	25	1.000
	0370810	100	200	25	900
	0370811	110	200	25	800
	0370812	120	200	25	700
	0370813	130	200	25	600
	0370814	140	200	25	600
	0370815	150	200	25	600
	0370816	160	200	25	500
	0370817	170	200	25	500
	0370818	180	200	25	500
	0370819	190	200	25	500
	0370820	200	200	25	400
	0370821	210	200	25	400
	0370822	220	200	25	400
	0370823	230	200	25	400
	0370824	240	200	25	300
	0370825	250	200	25	300
	0370826	260	200	25	300
	0370827	270	200	25	300
	0370828	280	200	25	300
	0370830	300	200	25	300
	0370832	320	200	25	300
	0370834	340	200	25	200
	0370835	350	200	25	200

Redondo pilotes

	Código	Medida	Grosor	Ø Hierro	Uds. Palet
	0350470	70	50	20	475
	0350475	75	80	20	240

Barra triángulo

	Código	Medida	Longitud (cm)	Uds. Palet
	0350520	20	100	1.500
	0350525	25	100	1.000
	0350530	30	100	750
	0350535	35	100	600
	0350540	40	100	400
	0350545	45	100	300
	0350550	50	100	250
	0350555	55	100	250
	0350560	60	100	250
	0350575	70	100	175

Barra cuadrado

	Código	Medida	Longitud (cm)	Uds. Palet
	0350620	20	100	1.000
	0350625	25	100	700
	0350630	30	100	500
	0350635	35	100	400
	0350640	40	100	250
	0350645	45	100	225
	0350650	50	100	200
	0350655	55	100	175
	0350660	60	100	125
	0350670	70	100	100
	0350675	75	100	100

Barra curva

	Código	Medida	Longitud (cm)	Uds. Palet
	0350720	20	80/100	1.000
	0350725	25	80/100	700
	0350730	30	80/100	500
	0350735	35	80/100	400
	0350740	40	80/100	250
	0350745	45	80/100	225
	0350750	50	80/100	200
	0350755	55	80/100	175
	0350760	60	80/100	125

Sin alambre

	Código	Medida	Uds. Saco	Uds. Palet
	0350120	20	700	35.000
	0350125	25	400	20.000
	0350130	30	300	15.000
	0350135	35	250	10.000
	0350140	40	200	8.000
	0350150	50	150	6.750
	0350163	60	125	4.800
	0350170	70	100	3.600

Con alambre

	Código	Medida	Uds. Saco	Uds. Palet
	0350020	20	500	20.000
	0350025	25	400	20.000
	0350030	30	300	13.500
	0350035	35	250	10.000
	0350040	40	250	10.000
	0350050	50	200	8.000
	0350060	60	125	4.800
	0350070	70	100	4.000

3D sin alambre

	Código	Medida	Uds. Saco	Uds. Palet
	0350160	20/25/30	700	28.000
	0350161	35/40/50	200	10.000
	0350162	45/55/60	125	5.000

3D con alambre

	Código	Medida	Uds. Saco	Uds. Palet
	0350260	20/25/30	600	24.000
	0350261	35/40/50	250	10.000
	0350262	45/55/60	125	5.000

Reticular

	Código	Medida	Longitud (cm)	Uds. Saco	Uds. Palet
	0350310	25	100	100	6.000
	0350312	25	120	100	6.000

Encofrado metálico

	Código	Medida	Uds. Paquete	Uds. Palet
	-	Consultar	Consultar	Consultar

Cajas metálicas que se utilizan para la sujeción de estructuras de hormigón prefabricadas.

Tapón hidroexpansivo

	Código	Diámetro (mm)	Uds. Saco	Uds. Palet
	0304952	22	320	-

Barra

	Código	Diámetro (mm)	Carga Rotura (T)	Embalaje
	8031506	15/17	19	25

Tuerca plato

	Código	Diámetro (mm)	Carga Rotura (T)	Uds. Saco
	8131506	15/17	17	50

Tuerca mariposa

	Código	Diámetro (mm)	Carga Rotura (T)	Uds. Saco
	8231506	15/17	19	50

Tuerca hexagonal

	Código	Diámetro (mm)	Carga Rotura (T)	Uds. Saco
	8131507	15/17	17	100



Tubo completo

	Código	Medida	Uds. Saco	Uds. Palet
	0307150	150	100	6.300
	0307160	160	100	6.300
	0307180	180	100	7.200
	0307200	200	100	7.700
	0307250	250	100	6.600
	0307300	300	100	5.400
	0307350	350	40	4.000
	0307400	400	30	3.000

Tubo

	Código	Diámetro (mm)	Uds. (m)	Uds. Palet (m)
	0304720	20/24	50	5.000
	0304722	22/26	50	3.000
	0304726	26/32	40	2.400

Cono

	Código	Diámetro (mm)	Uds. Saco	Uds. Palet
	0304620	20	1.000	100.000
	0304622	22	500	50.000
	0304626	26	1.000	54.000

Tapón

	Código	Diámetro (mm)	Uds. Saco	Uds. Palet
	0304820	20	1000	240.000
	0304822	22	1000	90.000
	0304826	26	500	90.000

Tapón universal

	Código	Diámetro (mm)	Uds. Saco	Uds. Palet
	0304890	10-35	2.000	80.000

Juego estanco

	Código	Diámetro (mm)	Uds. Saco	Uds. Palet
	0304922	Cono Estanco 22	200	144.000
	0304932	Tapón Estanco 22	200	48.000
	0304942	Tapón Elástico 22	200	132.000

Berenjeno sin ala

	Código	Medida	Longitud (cm)	Uds. Caja	Uds. Palet
	0360015	10	250	100	6.500
	0360021	13	250	250	2.500
	0360016	15	250	100	5.400
	0360028	20	250	125	2.500
	0360035	25	250	125	2.500
	0360040	30	250	125	2.500

Berenjeno con ala

	Código	Medida	Longitud (cm)	Uds. Caja	Uds. Palet
	0360111	11	250	100	5.000
	0360115	15	250	100	4.900
	0360120	20	250	50	2.400
	0360121	25	250	50	2.400
	0360130	30	250	50	1.800

Berenjeno metálico

	Código	Medida	Longitud (cm)	Peso (kg)
	0380007	7	300	0.6
	0380010	10	300	1.5
	0380015	15	300	3.0
	0380020	20	300	5.1
	0380025	25	300	7.8
	0380030	30	300	11.4

Berenjeno con ala estanco

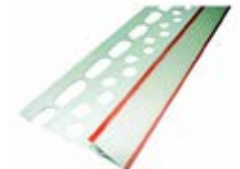
	Código	Medida	Longitud (cm)	Uds. Caja	Uds. Palet
	0360152	22x25	300	72	2.880
	0360153	22x25	300	72	2.880

Perfil trapezoidal

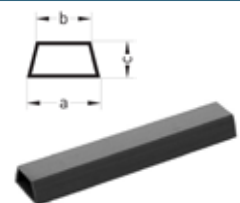
	Código	Medida (AxBxC)	Longitud (cm)	Uds. Caja	Uds. Palet
	0360210	20x10x10	250	100	5.400
	0360220	20x15x10	250	100	5.400
	0360230	30x20x15	250	100	4.200
	0360235	35x20x35	250	50	2.100

Perfil trapezoidal

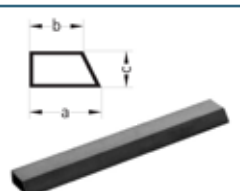
	Código	Medida (AxBxC)	Longitud (cm)	Uds. Caja	Uds. Palet
	0360250	20x15x10	250	100	5.400

Berenjeno goma

	Código	Medida	Longitud (cm)	Material
	0380110	10	100	Goma+Metal
	0380115	15	100	Goma+Metal
	0380120	20	100	Goma+Metal

Berenjeno imantado en un lado

	Código	Medida	% Iman	Longitud (cm)	Material
	0380211	10	100	200	Acero
	0380216	15	100	200	Acero
	0380222	20	100	200	Acero
	0380225	25	100	200	Acero
	-	30	100	200	Acero

Berenjeno imantado en ambos lados

	Código	Medida	% Iman	Longitud (cm)	Material
	-	10	50/100	200/300	Acero
	-	15	50/100	200/300	Acero
	-	20	50/100	200/300	Goma
	-	25	100	200/300	Acero
	-	30	100	200/300	Goma

Berenjeno imantado en la base

	Código	Medida	% Iman	Longitud (cm)	Material
	0380213	10	100	200	Acero
	0380218	15	100	200	Acero
	0380223	20	100	200	Acero
	-	25	100	200	Acero
	-	30	100	200	Acero

Listones imantados trapecio

	Código	Medida (AxBxC)	% Iman	Longitud (cm)	Material
	-	30x10x10	100	200-250	Acero
	-	40x10x15	100	200-250	Acero
	-	55x15x20	100	200-250	Acero

Listones imantados trapecio recto

	Código	Medida	Longitud (cm)	Material
	-	Consultar	200/300	Acero

Cruceta

	Código	Medida	Uds. Saco	Uds. Caja
	0304501	1	300	52.500
	0304502	2	300	52.500
	0304503	3	300	33.000
	0304505	5	300	15.000
	0304507	7	300	6.000
	0304510	10	300	2.400
	0304515	15	300	2.400

Cuña nivelación

	Código	Medida	Uds. Saco	Uds. Palet
	-	1	-	-
	-	2	-	-
	-	3	-	-
	-	Tapón	-	-

Nivelador

	Código	Medida	Uds. Saco	Uds. Palet
	0304540	Cuña	250	1.500
	0304541	1	250	1.500
	0304542	2	250	1.500
	0304543	3	250	1.500
	0304545	Alicate	1	10

Flotante

	Código	Medida	Uds. Saco	Uds. Palet
	0304573	3	100	24.000
	0304585	15	150	5.400

Cuña

	Código	Medida	Uds. Saco	Uds. Palet
	0304590	0-7	1.000	60.000

Pavés

	Código	Medida	Uds. Saco	Uds. Palet
	0304595	10	300	12.600

Guardacantos PVC

	Código	Color	Longitud (cm)	Uds. Caja	Uds. Palet
	0361010	Blanco	260	100	6.000
	0361011	Color	260	100	6.000

Junquillo PVC

	Código	Color	Longitud (cm)	Uds. Caja	Uds. Palet
	0361100	Blanco	200	130	7.800
	0361110	Color	200	130	7.800

Guardavivos PVC Yeso

	Código	Color	Longitud (cm)	Uds. Caja	Uds. Palet
	0361250	Blanco	250	100	6.000
	0361260	Blanco	260	100	6.000
	0361270	Blanco	270	100	6.000
	0361280	Blanco	280	100	6.000
	0361300	Blanco	300	100	6.000

Guardavivos PVC Monocapa

	Código	Color	Longitud (cm)	Uds. Caja	Uds. Palet
	0361400	Blanco	250	50	2.400

Esquinero PVC Monocapa

	Código	Color	Longitud (cm)	Uds. Caja	Uds. Palet
	0361410	Blanco	250	50	3.000
	0361420	Blanco	260	50	3.000

Esquinero PVC Monocapa

	Código	Color	Longitud (cm)	Uds. Caja	Uds. Palet
	0361430	Blanco	250	50	1.500

Doble super

	Código	Medida	Grueso Pared	Uds. Caja
	-	15	200-240-250-300-350-400	100
	-	20	200-240-250-300-350-400	100
	-	25	200-240-250-300-350-400	100
	-	30	200-240-250-300-350-400	100
	-	35	200-240-250-300-350-400	100
	-	40	200-240-250-300-350-400	100
	-	50	200-240-250-300-350-400	100

Doble

	Código	Medida	Grueso Pared	Uds. Saco	Uds. Palet
	0305108	20	80	1.000	72.000
	0305110	20	100	1.000	63.000
	0305112	20	120	1.000	54.000
	0305115	20	150	500	36.000
	0305180	20	180	500	36.000
	0305120	20	200	500	21.000
	0305125	20	250	500	15.000
0305130	20	300	250	10.000	

Muro Doble

Muro doble

	Código	Medida	Grueso Pared	Uds. Saco	Uds. Palet
	0381112	15-35	120	150	3.000
	0381115	15-35	150	150	3.000
	0381118	15-35	180	150	3.000
	0381120	15-35	200	150	3.000
	0381124	15-35	240	150	3.000
	0381125	15-35	250	150	3.000
	0381130	15-35	300	150	3.000
	0381135	15-35	350	100	2.000
	0381136	15-35	365	100	2.000
	0381140	15-35	400	100	2.000
	0381150	15-35	500	100	2.000

Muro doble-P

	Código	Medida	Grueso Pared	Uds. Saco	Uds. Palet
	0381218	15-50	180	54	2.430
	0381220	15-50	200	54	2.430
	0381224	15-50	240	85	2.720
	0381225	15-50	250	85	2.720
	0381230	15-50	300	85	1.530
	0381235	15-50	350	-	420
	0381240	15-50	400	-	420

Seta protectora

	Código	Ø Hierro	Uds. Saco	Uds. Palet
	0304030	12/25	300	27.000

Seta cuadrada

	Código	Ø Hierro	Uds. Saco	Uds. Palet
	0304031	12/24	100	15.000
	0304032	24/40	200	6.000

Punta protectora

	Código	Ø Hierro	Uds. Saco	Uds. Palet
	0304033	8/16	500	50.000

Guardacuerpo cilíndrico

	Código	Medida	Uds. Saco	Uds. Palet
	0304040	Ø 40x130	200	6.000

Guardacuerpo cilíndrico/cuadrado

	Código	Medida	Uds. Saco	Uds. Palet
	0304050	Ø 40/35x35	150	5.400

Guardacuerpo cuadrado

	Código	Medida	Uds. Caja	Uds. Palet
	0304060	80x85	45	1.350

Caja de seguridad

	Código	Medida	Uds. Caja	Uds. Palet
	0304045	45X45X120	100	5.400

Bovedilla

	Código	Medida	Ø Hierro	Uds. Saco	Uds. Palet
	0304201	30	16	200	10.000

Bovedilla poliestireno

	Código	Medida	Ø Hierro	Uds. Saco	Uds. Palet
	0304202	60	16	100	10.000

Bovedilla

	Código	Medida	Ø Hierro	Uds. Saco	Uds. Palet
	0304203	30	25	200	10.000

Bovedilla poliestireno

	Código	Medida	Ø Hierro	Uds. Saco	Uds. Palet
	0304204	60	25	100	10.000

Reticular

	Código	Medida	Longitud (cm)	Uds. Saco	Uds. Palet
	0350310	25	100	100	6.000
	0350312	25	120	100	6.000

Reticular parrilla

	Código	Medida	Dimensiones	Uds. Caja	Uds. Palet
	0370226	25	160x120	280	8.400
	0370227	30	180x140	250	7.200
	0370230	30	200x100	250	7.200
	0370231	30	200x100 (Divisible)	230	5.000

Huevera

	Código	Medida	Uds. Saco	Uds. Palet
	0301110	10+10	200	10.000

Ladrillo

	Código	Medida	Uds. Saco	Uds. Palet
	0301150	40x70x150	65	1.755

Cuña apoyos tubos

	Código	Medida	Uds. Saco	Uds. Palet
	-	138x107x52	100	-
	-	197x137x66	50	-

Cantonera

	Código	Medida	Uds. Saco	Uds. Palet
	-	131(105)x95	100	-

Cantonera eslinga

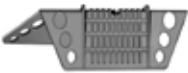
	Código	Medida	Uds. Saco	Uds. Palet
	0301130	350X150	30	-

Cantonera eslinga

	Código	Medida	Uds. Saco	Uds. Palet
	0301131	154x181	25	-

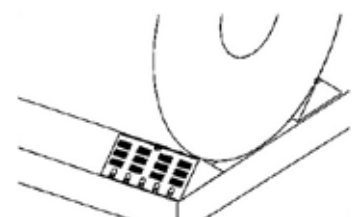
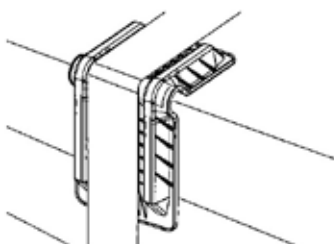

Perfil para mesa

	Código	Medida	Dureza	Separador
	0430014	85x18	65° Sh	60

Perfil para mesa

	Código	Medida	Dureza	Separador
	0430010	65.5x17.3	65° Sh	40

Perfil para mesa

	Código	Medida	Dureza	Separador
	0440010	27x10	65° Sh	8

Perfiles de caucho esponjoso

	Material	Adhesivo
	Natural	Con / Sin
	Neopreno	Con / Sin
	EPDM	Con / Sin

Medidas disponibles

mm	2	3	4	5	6	7	8	10	12	15	18	20	25	30	35	40	50
6	☺	☺	☺	☺	☺												
8	☺	☺	☺	☺	☺	☺	☺										
10	☺	☺	☺	☺	☺	☺	☺	☺									
12	☺	☺	☺	☺	☺	☺	☺	☺	☺								
15	☺	☺	☺	☺	☺	☺	☺	☺	☺	☺							
18	☺	☺	☺	☺	☺	☺	☺	☺	☺	☺	☺						
20	☺	☺	☺	☺	☺	☺	☺	☺	☺	☺	☺	☺					
25	☺	☺	☺	☺	☺	☺	☺	☺	☺	☺	☺	☺	☺				
30	☺	☺	☺	☺	☺	☺	☺	☺	☺	☺	☺	☺	☺	☺			
35	☺	☺	☺	☺	☺	☺	☺	☺	☺	☺	☺	☺	☺	☺	☺		
40	☺	☺	☺	☺	☺	☺	☺	☺	☺	☺	☺	☺	☺	☺	☺	☺	
45	☺	☺	☺	☺	☺	☺	☺	☺	☺	☺	☺	☺	☺	☺	☺	☺	
50	☺	☺	☺	☺	☺	☺	☺	☺	☺	☺	☺	☺	☺	☺	☺	☺	☺
60	☺	☺	☺	☺	☺	☺	☺	☺	☺	☺	☺	☺	☺	☺	☺	☺	☺
70	☺	☺	☺	☺	☺	☺	☺	☺	☺	☺	☺	☺	☺	☺	☺	☺	☺
80	☺	☺	☺	☺	☺	☺	☺	☺	☺	☺	☺	☺	☺	☺	☺	☺	☺
90	☺	☺	☺	☺	☺	☺	☺	☺	☺	☺	☺	☺	☺	☺	☺	☺	☺
100	☺	☺	☺	☺	☺	☺	☺	☺	☺	☺	☺	☺	☺	☺	☺	☺	☺

Bandas de caucho (neopreno)

	Código	Espesor	Ancho	Largo
	-	1-20	A medida	A medida

Apoyos de caucho zunchados (neopreno)

	Código	Espesor	Ancho	Largo
	-	A medida	A medida	A medida

Apoyos de caucho zunchados (neopreno)

	Código	Espesor	Ancho	Largo
	-	A medida	A medida	A medida

Apoyos de caucho zunchados en cuña

	Código	Espesor	Ancho	Largo
	-	A medida	A medida	A medida

Apoyos de caucho gofrados

	Código	Espesor	Ancho	Largo
	-	A medida	A medida	A medida

Apoyos de caucho anclados perno

	Código	Espesor	Ancho	Largo
	-	A medida	A medida	A medida

Apoyos de caucho anclados reemplazable

	Código	Espesor	Ancho	Largo
	-	A medida	A medida	A medida

Apoyos de caucho deslizante

	Código	Espesor	Ancho	Largo
	-	A medida	A medida	A medida

Tapón tubo

		Tipo		Medidas													
		Cuadrado		Tabla													
		Rectangular		tabla													
Medidas disponibles																	
mm	10	15	16	18	20	22	25	30	35	40	45	46	50	60	70	80	100
10					☺		☺	☺									
15					☺		☺	☺		☺							
16			☺														
18				☺													
20					☺			☺	☺	☺			☺	☺		☺	
22						☺											
25							☺						☺	☺			
30								☺		☺			☺	☺		☺	
35									☺								
40										☺			☺	☺	☺	☺	☺
45											☺						
50													☺				☺
60														☺		☺	☺
70															☺		
80																☺	
100																	☺

Tapón plano tubo

		Tipo		Medidas							
		Cuadrado		Tabla							
		Rectangular		tabla							
Medidas disponibles											
mm	10	15	16	20	25	30	35	40	50	100	
10				☺		☺					
15						☺					
16			☺	☺							
20						☺	☺	☺	☺	☺	
25					☺				☺		
30						☺					

Vaina

	Código	Trenzado	Longitud (cm)	Uds. Paq.	Uds. Palet
	0304905	0.5"	300	60	10.800
	0304906	0.6"	300	60	10.800

Cables

	Código	Medida	Longitud (cm)	Uds. Saco	Uds. Palet
	0304940	30	410	100	1.000
	0304960	30	610	100	1.000

Vaina corrugada metálica

	Código	Medida	Longitud (cm)
	1405051	Ø51x59	100-200-300-400-500-600
	1405063	Ø63x72	100-200-300-400-500-600
	1405075	Ø75x85	100-200-300-400-500-600
	1405081	Ø81x88	100-200-300-400-500-600
	1405090	Ø90x97	100-200-300-400-500-600
	1405100	Ø100x107	100-200-300-400-500-600
	1405110	Ø110x117	100-200-300-400-500-600
	1405120	Ø120x127	100-200-300-400-500-600
	1405130	Ø130x137	100-200-300-400-500-600
	1405140	Ø140x147	100-200-300-400-500-600
	1405160	Ø160x167	100-200-300-400-500-600

Otras medidas: consultar

Tapón vaina metálica

	Código	Medida	Uds. Saco
	1405351	Ø51	-
	1405363	Ø63	-
	1405375	Ø75	-
	1405381	Ø81	-
	1405390	Ø90	-
	1405400	Ø100	-
	1405410	Ø110	-
	1405420	Ø120	-
	1405430	Ø130	-
	1405440	Ø140	-
	1405460	Ø160	-

Calzos 93x97

	Código	Espesor	Uds. Saco	Uds. Palet
	0370102	2+4	130	3.900

Calzo ranura 70x70

	Código	Espesor	Uds. Saco	Uds. Palet
	0342302	2	250	25.000
	0342305	5	125	20.000
	0342310	10	125	5.000
	0342315	15	50	4.000
	0342320	20	50	3.000
0342330	30	50	3.000	

Calzo 205x205

	Código	Espesor	Uds. Saco	Uds. Palet
	0340205	5 (Ø 32)	50	-
0340210	10 (Ø 32)	25	-	

Calzo perforado 200x200

	Código	Espesor	Uds. Saco	Uds. Palet
	0342420	20	10	1.400
0342440	40	5	750	

Base grua

	Código	Medidas	Toneladas	Asa
	3060002	40x40x4	-	Sí/No
	3060003	50x50x4	-	Sí/No
-	Cualquier medida	Cualquier Tonelada	Sí/No	

Calzo 80x80

	Código	Espesor	Uds. Saco	Uds. Palet
	0342002	2	500	25.000
	0342005	5	300	15.000
	0342010	10	300	15.000
	0342020	20	100	5.000

Calzo 100x100

	Código	Espesor	Uds. Saco	Uds. Palet
	0340402	2	500	25.000
	0340405	5	300	15.000
	0340410	10	300	15.000
	0340420	20	100	5.000

Calzo 160x80

	Código	Espesor	Uds. Saco	Uds. Palet
	0340302	2	400	20.000
	0340305	5	200	10.000
	0340310	10	130	6.500
	0340320	20	20	1.000

Calzo 160x40

	Código	Espesor	Uds. Saco	Uds. Palet
	0340102	2	1.000	25.000
	0340105	5	500	15.000
	0340110	10	320	15.000
	0340120	20	100	5.000

Cuña de calzado

	Código	Medidas	Uds. Saco	Uds. Palet
	0303009	80x45x20	200	18.000
	0303007	110x40x20	250	12.500
	0303001	100x100x40	100	7.000
	0303004	220x100x70	400	800
	0303006	300x100x70	400	800

Cuña peine

	Código	Medidas	Uds. Saco	Uds. Palet
	0370150	60x30x10	1.000	-

Certificado a compresión

CEICO certifica: que la información obtenida de los ensayos, permite afirmar que todas las muestras sometidas a una fuerza creciente de forma progresiva y uniforme son capaces de soportar más de **220 Tn.** sin que se produzca su colapso.

Tabla barra/armadura

		Barras de armadura										
		Ø	5	8	10	12	15	18	20	22	25	30
Barras de armadura	5	80	80	100	100	100	120	120	120	120	140	160
	8	80	80	100	100	120	120	140	140	140	140	160
	10	100	100	100	120	120	120	140	140	140	140	160
	12	100	100	120	120	120	140	140	140	140	160	180
	15	100	120	120	120	140	140	140	160	160	160	180
	18	120	120	120	140	140	160	160	160	160	180	190
	20	120	140	140	140	140	160	160	180	180	180	190
	22	120	140	140	140	140	160	160	180	180	190	200
	25	140	140	140	160	160	180	180	180	190	190	200
	30	160	160	160	160	160	190	190	190	200	200	220

Longitud de los alambrillos

Alambrillo simple

	Código	Longitud (cm)	Ø Alambre	Rollos*/Saco	Rollos*/Palet
	0306150	80	1.1	30	480
	0306100	100	1.1	25	350
	0306120	120	1.1	20	300
	0306140	140	1.1	20	300
	0306165	160	1.1	15	240
	0306170	180	1.1	15	240
	0306200	200	1.1	15	210
	0306220	220	1.1	15	210

*1 Rollo = 1.000 Unidades

Alambrillo doble

	Código	Longitud (cm)	Ø Alambre	Rollos*/Saco	Rollos*/Palet
	0306081	80	1.1	-	400
	0306101	100	1.1	-	400
	0306180	120	1.1	-	400
	0306141	140	1.1	-	400
	0306102	160	1.1	-	300
	0306181	180	1.1	-	300
	0306200	200	1.1	-	200
	0306222	220	1.1	-	200

*1 Rollo = 1.000 Unidades

Atador

	Código	Descripción
	0306190	Atador de Alambrillos

Gancho rápido

	Código	Longitud (cm)	Ø Sop.	Ø Mont.	Uds. Cartón
	-	8/8	7-8	8-8	10.000
	-	8/10	5-6-8	10-10-10	13.000
	-	8/12	5-6-8	12-12-12	10.000
	-	8/14	5-6-8	14-14-14	10.000
	-	8/16	6-8-10	16-16-16	8.000
	-	8/18	6-8-10	18-18-18	5.600
	-	8/20	6-8-10	20-20-20	5.600
	-	8/22	6-7-8	22-22-22	4.000
	-	8/24	6-7-8	24-24-24	5.600

Otras medidas: consultar

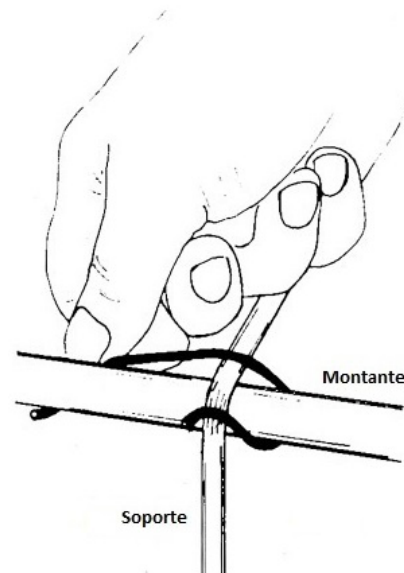
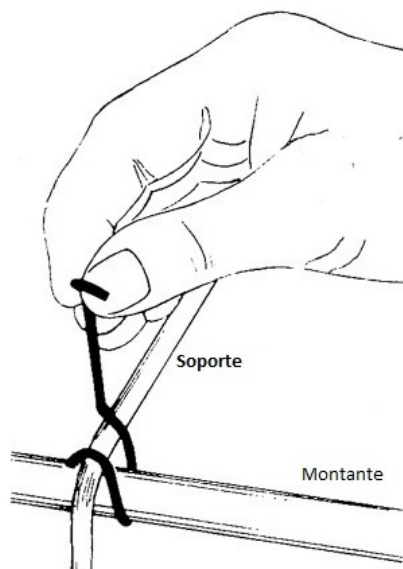

Gancho rápido separador

	Código	Medida	Ø Hierro	Uds. Cartón
	-	10-15-20-25	4/4	3.000
	-	10-15-20-25	4/5	3.000
	-	10-15-20-25	5/5	3.000
	-	10-15-20-25	5/6	3.000
	-	10-15-20-25	6/6	3.000
	-	10-15-20-25	6/8	3.000

Clip rápido

	Código	Ø Hierro	Uds. Saco	Uds. Palet
	0306910	6/8	8.000	48.000
	0306920	6/10	8.000	48.000
	0306930	6/12	8.000	48.000
	0306940	8/8	8.000	48.000
	0306950	8/10	8.000	48.000

Cabezal para bulón pie

	Código	Toneladas	Ø	Uds. Saco	Uds. Palet
	0301302	2,5	71	200	12.000
	0301305	5	97	100	6.000
	0301310	7,5-10	117	50	3.000

Bulón pie

	Toneladas	Longitud (cm)
	1,3	35-40-45-50-55-65-85-120-170-240
	2,5	40-45-55-65-85-100-120-140-170-210-240-270
	4	55-65-75-85-95-100-120-150-170-210-220-240-300-340
	5	55-65-75-85-95-100-110-120-140-160-170-180-210-240-300-340-340-180
	7,5	85-95-100-105-110-120-140-150-160-165-200-300-540-600
	10	115-120-135-140-150-165-170-200-210-220-250-300-325-340-420-500-540-650-680
	15	110-120-140-165-180-200-240-300-400-550-650-840
	20	165-180-200-230-240-250-300-340-500-1000
	32	200-250-260-280-320-500-700-1000-1200

Gancho bulón pie

	Código	Toneladas	Longitud (cm)
	-	1,3	0,89
	1410103	2,5	1,62
	1410102	5	3,18
	1410101	7,5-10	9,70
	-	15-20	26,20
	-	32	45,80

Relleno goma bulón pie

	Código	Toneladas	Uds. Saco	Modelo
	1402985	1.0 – 1.3	-	REDONDO/OVALADO
	1402990	1.5 – 2.5	-	REDONDO/OVALADO
	1402994	3.0 – 5.0	-	REDONDO/OVALADO
	-	7.5 – 10.0	-	REDONDO/OVALADO
	1402915	15.0 – 20.0	-	REDONDO
	-	32	-	REDONDO

Bulón plano

	Código	Toneladas	Longitud
	-	0,7	110
-	1,4	110-160	
-	2	130-160-210	
-	2,5	150-200-250	
-	3	160-200-280	
-	4	180-240-320	
-	5	180-240-400	
-	5,3	220-260-340	
-	7,5	260-300-420	
-	10	300-370-520	
-	14	370-460	
-	17	500	
-	22	500-620	

Bulón plano volteo

	Código	Toneladas	Longitud
	-	1,4	200
-	2,5	230	
-	4	270	
-	5	290	
1475320	7,5	320	
-	10	390	
-	12,5-17-22	500	

Bulón plano corto

	Código	Toneladas	Longitud
	-	0,7-1,4-2-2,5	90
-	3-4-5	120	
-	5,3-7,5	160	
-	10	170	
-	14	240	
-	17-22-26	300	

Bulón plano base

	Código	Toneladas	Altura	Base
	-	1,4	50	80x80
-	2,5	80	80x80	
-	5	120	100x100	
-	10	160	140x140	

Bulón plano abierto

	Código	Toneladas	Altura
	-	0,7-1,4	60
	-	2-2,5	70
	-	3	90
	-	4	110
	-	5	120
	-	5,3	150
	-	7,5	170
	-	10	200
	-	12,5	220
	-	17	270
	-	22	310

Gancho bulón plano

	Código	Toneladas	Peso (kg)
	-	2,5	1,08
	-	5	2,88
	-	10	7
	-	26	23

Relleno goma bulón plano

	Código	Toneladas	Uds. Saco
	-	1,25	-
	-	2,5	-
	1402975	5,0	-
	-	10	-
	-	14-26	-

Casquillo

	Código	Toneladas	Métrica	Longitud
	1500105	0,5	Rd 12	40
	1500108	0,8	Rd 14	48
	-	1,2	Rd 16	54
	-	1,6	Rd 18	65
	1500001	2	Rd 20	70
	-	2,5	Rd 24	80
	-	4	Rd 30	101
	-	6,3	Rd 36	125
	-	8	Rd 42	140
	-	12,5	Rd 52	170

Galbanizado o Acero Inoxidable

Casquillo plano

	Código	Toneladas	Métrica	Longitud
	-	0,5	Rd 12	60-80
	-	1,2	Rd 16	90-100
	-	2	Rd 20	95
	-	2,5	Rd 24	100-120
	-	4	Rd 30	135-150

Galbanizado o Acero Inoxidable

Tornillo lazo

	Código	Métrica	Toneladas
	1500205	Rd 12	0,5
	1500208	Rd 14	0,8
	-	Rd 16	1,2
	-	Rd 18	1,6
	1500050	Rd 20	2
	-	Rd 24	2,5
	-	Rd 30	4
	-	Rd 36	6,3
	-	Rd 42	8
	-	Rd 52	12,5

Casquillo con barra

	Código	Toneladas	Métrica	Longitud
	-	0,5	Rd 12	190
-	0,8	Rd 14	230	
-	1,2	Rd 16	250	
-	1,6	Rd 18	300	
-	2	Rd 20	350	
-	2,5	Rd 24	400	
-	4	Rd 30	500-900	
-	6,3	Rd 36	650-900	
-	8	Rd 42	800	
-	12,5	Rd 52	900	
-	15	Rd 56	1200	
-	20	Rd 60	1400	

Galbanizado o Acero Inoxidable

Casquillo con barra

	Código	Toneladas	Métrica	Longitud
	-	0,5	Rd 12	137
-	0,8	Rd 14	170	
-	1,2	Rd 16	216	
-	1,6	Rd 18	235	
-	2	Rd 20	257	
-	2,5	Rd 24	360	
-	4	Rd 30	450	
-	6,3	Rd 36	570	
-	8	Rd 42	620	
-	12,5	Rd 52	880	
-	15	Rd 56	1200	
-	20	Rd 60	1400	
-	22	Rd 48	1260	

Galbanizado o Acero Inoxidable

Casquillo con barra

	Código	Toneladas	Métrica	Longitud
	-	0,5	Rd 12	108
-	0,8	Rd 14	130	
-	1,2	Rd 16	167	
-	1,6	Rd 18	175	
-	2	Rd 20	187	
-	2,5	Rd 24	240	
-	4	Rd 30	300	
-	6,3	Rd 36	380	
-	8	Rd 42	450	

Galbanizado o Acero Inoxidable

Tornillo anillo

	Código	Métrica	Toneladas
	-	Rd12	0,5
	-	Rd14	0,8
	-	Rd16	1,2
	-	Rd18	1,6
	-	Rd20	2
	1500302	Rd24	2,5
	1500304	Rd30	4
	-	Rd36	6,3
	-	Rd42	8
-	Rd52	12,5	

Tapón casquillo

	Código	Métrica
	-	Rd 10
	-	Rd 12
	-	Rd 14
	-	Rd 16
	-	Rd 18
	-	Rd 20
	-	Rd 24
	-	Rd 30
	-	Rd 36
	-	Rd 42
	-	Rd 52

Gancho doble muro

	Código	Toneladas	Ø Hierro Hormigón	Ancho pared
	-	2	12 Corrugado	180-300
	-	2	12 Liso B1	180-300
	-	2,7	14 Corrugado	180-300
	-	2,7	14 Liso B1	180-300
	-	3,5	16 Corrugado	180-300
	-	3,5	16 Liso B1	180-300
	-	5	20 Corrugado	180-300
	-	5	20 Liso B1	180-300

Con o Sin gancho de fijación

Panel sandwich redondo

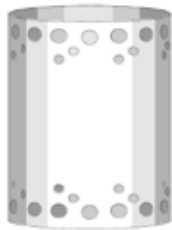
	Código	Ø Diametro	Altura	Espesor	
	-	51-76-102-127-153-178-204-229-255-280		150	1,5
	-	51-76-102-127-153-178-204-229-255-280		175	1,5
	-	51-76-102-127-153-178-204-229-255-280		200	1,5
	-	51-76-102-127-153-178-204-229-255-280		225	1,5
	-	51-76-102-127-153-178-204-229-255-280		250	1,5
	-	51-76-102-127-153-178-204-229-255-280		260	1,5
	-	51-76-102-127-153-178-204-229-255-280		280	1,5
	-	51-76-102-127-153-178-204-229-255-280		300	1,5
	-	51-76-102-127-153-178-204-229-255-280		320	1,5
	-	51-76-102-127-153-178-204-229-255-280		330	1,5
	-	51-76-102-127-153-178-204-229-255-280		340	1,5
-	51-76-102-127-153-178-204-229-255-280		360	1,5	

Panel sandwich plano

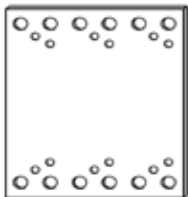
	Código	Ancho	Altura	Espesor	
	-	40-80-120-160-200-240-280-320-360-400		150	1,5-2
	-	40-80-120-160-200-240-280-320-360-400		175	1,5-2
	-	40-80-120-160-200-240-280-320-360-400		200	1,5-2
	-	40-80-120-160-200-240-280-320-360-400		225	1,5-2
	-	40-80-120-160-200-240-280-320-360-400		250	1,5-2
	-	40-80-120-160-200-240-280-320-360-400		260	1,5-2
	-	40-80-120-160-200-240-280-320-360-400		280	1,5-2

Horquilla

	Código	Longitud (cm)	Ø Hierro	
	-	220-300-360		2,5
	-	120-140-160-180-200-220-240		3
	-	160-180-200-220-230-240-250-260-270		4
	-	280-300-320-340-350-360-380-400		4
	-	200-220-230-240-250-260-280-300-320-330-340-360-380-400		5
	-	200-220-240-260-280-300-320-340-355-360-380-400-420		6

Acero inoxidable 1.4401

Horquilla con perno

	Código	Longitud (cm)	Ø Hierro	
	-	120-140-160-180-200-220-240		3
	-	120-140-150-160-180-200-220-230-240-250-260-280		4
	-	200-220-240-250-260-280-300-320-340-360-380-400-420		5
	-	260-280-300-320-330-340-360-380-400-420-330		6

Acero inoxidable 1.4401

Fijación aislamiento

	Código	Medida	Uds. Saco	Uds. Palet
	0305307	75	5.000	100.000
	0305309	90	5.000	100.000
	0305310	100	3.000	60.000
	0305312	125	2.500	50.000
	0305315	150	2.500	50.000
	0305317	175	2.000	40.000
	0305320	200	1.000	20.000
	0305323	235	-	10.000
	0305325	250	-	10.000
0305330	300	-	10.000	

Fijación aislamiento

	Código	Medida	Uds. Saco
	0305305	50	2.500
	0305316	150	500

Alveolar

Tapón alveolar

	Código	Medida	Uds. Caja	Uds. Palet
	0305220	16-20	-	3.850
	0305226	26	180	4.500
	0305232	32	100	2.500
	0305240	40	80	2.000
	0305250	50	-	-

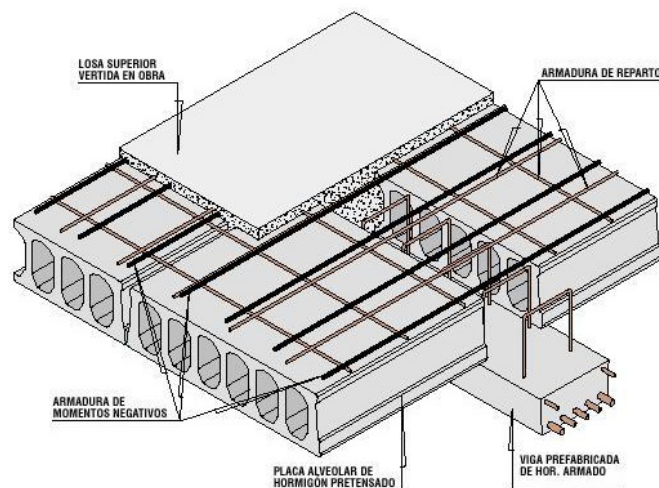

Viga celosía

	Código	Medida	Uds. Saco	Uds. Palet
	0304122	22	300	15.000
	0304131	30	300	15.000

Viga celosía

	Código	Medida	Uds. Saco	Uds. Palet
	0304118	18	300	19.500

Viga celosía

	Código	Medida	Uds. Saco	Uds. Palet
	0304015	15	300	-

Viga celosía

	Código	Medida	Uds. Saco	Uds. Palet
	0304014	14	-	-

Viga celosía

	Código	Medida	Uds. Saco	Uds. Palet
	0304024	24	1.000	40.000

Viga celosía con centradores

	Código	Medida	Longitud (cm)	Uds. Saco	Uds. Palet
	0341015	15	110	400	22.400
	0341020	20	110	400	22.400
	0341025	25	110	400	22.400
	0341515	15	115	400	22.400
	0341520	20	115	400	22.400
	0341525	25	115	400	22.400
	0341815	15	118	400	22.400
	0341820	20	118	400	22.400
	0341825	25	118	400	22.400
	0341915	15	120	400	22.400
	0341920	20	120	400	22.400
	0341925	25	120	400	22.400

Viga celosía con guías

	Código	Medida	Longitud (cm)	Uds. Saco	Uds. Palet
	0361015	15	110	400	22.400
	0361020	20	110	400	22.400
	0361025	25	110	400	22.400
	0361515	15	115	400	22.400
	0361520	20	115	400	22.400
	0361525	25	115	400	22.400
	0361815	15	118	400	22.400
	0361820	20	118	400	22.400
	0361825	25	118	400	22.400
	0361915	15	120	400	22.400
	0361920	20	120	400	22.400
	0361925	25	120	400	22.400

Cinta perimetral

	Código	Ancho	Galga	Color
	3000207	100	200	Blanco/Rojo

Cinta perimetral

	Código	Ancho	Galga	Color
	3000206	100	200	Amarillo/Negro

Cinta señalización

	Código	Ancho	Galga	Color
	3000202	150	200	Amarillo

Cinta señalización

	Código	Ancho	Galga	Color
	3000203	150	200	Rojo

Cinta señalización

	Código	Ancho	Galga	Color
	3000204	150	200	Verde

Cinta señalización

	Código	Ancho	Galga	Color
	3000205	200	300	Azul

Cinta a medida

	Código	Ancho	Galga	Color
	-	80	200-300	A Elegir
	-	100	200-300	A Elegir
	-	150	200-300	A Elegir
-	200	200-300	A Elegir	

Banderolas

	Código	Refractante	Uds. Bolsa (ml)	Uds. Palet (ml)
	3000210	Sí	10	-
	3000211	No	10	-

Tapongia

	Código	Medida	Ø Hierro	Uds. Saco
	0304004	3	4	1.000
	0304006	3	6	7.000
	0304007	3	7	7.000
	0304008	3	8	7.000
	0304009	3	8.5	7.000
	0303010	3	10	7.000

Condor

	Código	Medidas	Uds. Saco	Uds. Palet
	0304550	15-20-25-30	1.000	63.000

Base poliestireno

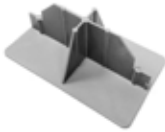
	Código	Medidas	Uds. Saco	Uds. Palet
	0303301	130x80x50	336	5.376

Giabaldosa

	Código	Uds. Saco	Uds. Palet
	0303500	2.500	50.000

Cubeta cata

	Código	Medidas	Uds. Saco	Uds. Palet
	0303550	15x15x15	12	192

Cubeta cata cilíndrica

	Código	Medida	Uds. Saco	Uds. Palet
	-	Ø100X200	12	192
	-	Ø150X300	12	192
	-	Ø160X320	12	192

Funda para palet

	Código	Medida	Impresión	Colores	Galga
	-	A elegir	Con/Sin	A elegir	A elegir
	Funda retráctil o no retráctil				
	Polietileno 100% Virgen				
Impresión hasta 3+3 tintas					

Funda para tubo

	Código	Largo	Ancho	Alto	Galga
	-	A elegir	A elegir	A elegir	A elegir
	Funda no retráctil				
	Polietileno 100% Virgen				

Lámina cubre palet

	Código	Medida	Impresión	Colores	Galga
	-	A elegir	A elegir	A elegir	A elegir
	Polietileno 100% Virgen				
	Impresión hasta 3+3 tintas				

Soplete para retráctil

	Código	Medida	Gas
	300700	30 cm	Butano
	300700	30 cm	Propano
	300701	Regulador	-

Film estirable manual

	Código	Ancho	Micras	Peso (kg)
	-	50	20	2,4
	0242301	50	23	2,4
	-	50	30	2,4
	-	50	A elegir	A elegir

Dispensador de bobinas film estirable

	Código	Medidas	Uds. Saco	Uds. Palet
	3000150	Ø 50mm	25	-

Pate polipropileno armado

Código	Modelo	Medidas							Uds. Caja
		A	B	C	D	E	F	G	
1200004	400 C-R plus	380	407	80	190	270	388.77	402	25
1200005	340 C-R plus	340	367	80	190	270	349.77	362	25
1200006	330 C-R plus	330	357	80	190	270	339.77	352	25
1200007	300 C-R plus	300	327	80	190	270	309.77	322	25
1200008	400 C-R	380	407	80	160	240	389.77	402	25
1200009	340 C-R	340	367	80	160	240	349.77	362	25
1200003	330 C-R	330	357	80	160	240	339.77	352	25
1200006	300 C-R	300	327	80	160	240	309.77	422	25
1200009	EcoPate 330	330	357	80	120	200	338.77	352	40
1200011	EcoPate 320	320	347	80	120	200	328.77	342	40
1200012	EcoPate 300	300	327	80	120	200	308.77	322	40

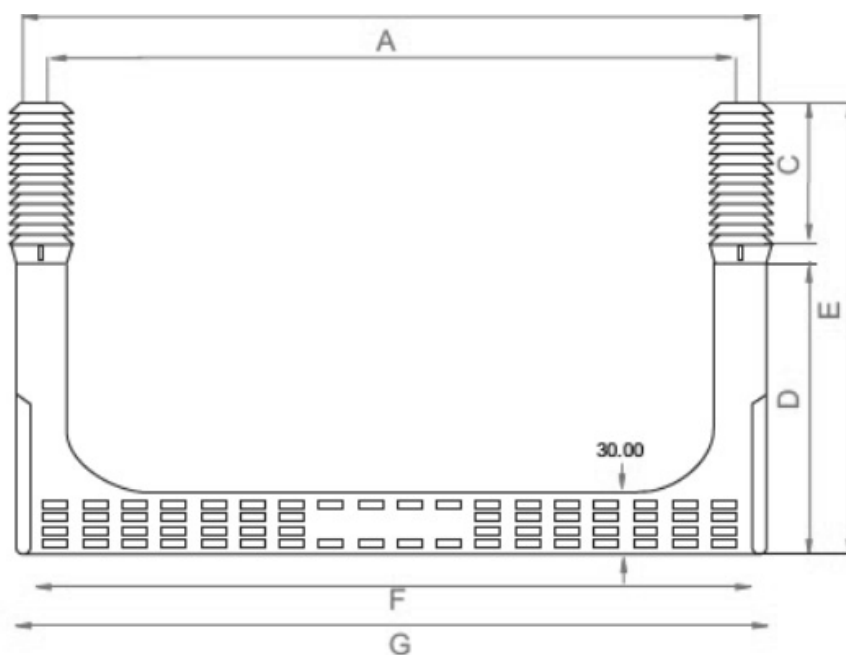

Unico **Pate** en el mercado que cumple y supera las siguientes normas: española **UNE 127011 EX**, americana **ASTM C-478** y **C- 497** y alemana **DIN 19555**. 400 C-R PLUS. Unico **Pate** en el mercado que cumple y supera la **LPRL 31/1995**, ley de prevención de riesgos laborales, y el **Real Decreto 486/1997**, disposiciones mínimas de seguridad y salud en los lugares de trabajo.

Junta dilatación

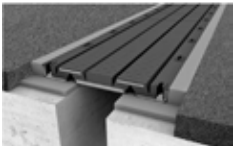
	Código	Medida	Longitud (cm)	Movimiento
	0450050	210x34	183,5	25
	0450075	220x35	183,5	37,5

Soleras

	Código	Medida	Longitud (cm)	Uds. Caja
	0307640	40	300	240
	0307680	80	250	50

Pavimentos mortero

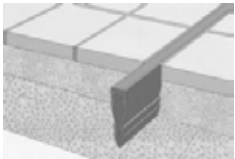
	Código	Medida	Longitud (cm)	Uds. Caja
	0307730	8x30	250	100
	0307750	8x50	250	100
	0307760	8x60	250	100
	0307775	8x75	250	100
	0307790	8x90	250	100

Waterstop

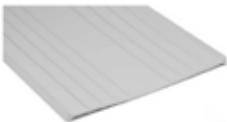
	Código	Medida	Longitud (cm)	Uds. Palet
	0307815	150	2.500	1.500
	0307820	200	2.500	1.200
	0307822	220	2.500	1.050
	0307825	250	2.500	900
	0307830	300	2.500	750
	0307836	360	2.500	200

Waterstop con bulbo

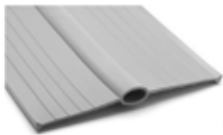
	Código	Medida	Longitud (cm)	Uds. Palet
	0307915	150	2.500	525
	0307920	200	2.500	450
	0307922	220	2.500	375
	0307925	250	2.500	350
	0307930	300	2.500	200

Imán lingote

	Código	Medida (mm)	F. Adherencia (Kg)
	1420105	125x(54/45)x35	350
	1420110	125x(54/45)x25	400
	1420115	250x(54/45)x25	900
	1420120	250x(54/45)x35	900
	1420125	300x(54/45)x35	900
	1420130	320x(84/75)x35	1.800

Palanca

	Código	Descripción	F. Adherencia (Kg)
	1420100	Palanca	350-400-900

Imán con caja

	Código	Medida (mm)	F. Adherencia (Kg)
	1420205	170x60x40	500
	1420210	280x60x40	900
	1420215	360x90x60	1.350
	1420220	320x120x60	1.800
	1420225	320x120x60	2.100
	1420230	320x120x60	3.000

Palanca

	Código	Descripción	F. Adherencia (Kg)
	1420200	Palanca	500
	1420201	Palanca	900
	1420202	Palanca	1.350-1.800-2.100-3.000

Madera

Código: 6012001 Medidas: 4.000x1.305	Código: 6012002 Medidas: 4.000x1.200	Código: 6012003 Medidas: 4.000x1.250
Código: 6012004 Medidas: 4.000x1.250	Código: 6012005 Medidas: 4.000x1.300	Código: 6012006 Medidas: 4.000x1.300
Código: 6012007 Medidas: 4.000x1.200	Código: 6012008 Medidas: 4.000x1.285	Código: 6012009 Medidas: 4.000x1.230
Código: 6012010 Medidas: 4.000x1.200	Código: 6012011 Medidas: 4.000x1.230	Código: 6012012 Medidas: 4.000x1.200
	Código: 6012013 Medidas: 4.000x1.200	

Otros modelos consultar

Formas

					
Código: 6012021	Medidas: 4.000x1.300	Código: 6012023	Medidas: 4.000x1.200	Código: 6012025	Medidas: 4.000x1.250
					
Código: 6012026	Medidas: 4.000x1.200	Código: 6012027	Medidas: 4.000x1.200	Código: 6012025	Medidas: 4.000x1.200

Otros modelos consultar

Piedra

					
Código: 6012051	Medidas: 4.000x1.250	Código: 6012052	Medidas: 4.000x1.250	Código: 60120553	Medidas: 4.000x1.250
					
Código: 6012054	Medidas: 4.000x1.200	Código: 6012054	Medidas: 4.000x1.210	Código: 6012056	Medidas: 4.000x1.200
					
Código: 6012055	Medidas: 4.000x1.200	Código: 6012058	Medidas: 4.000x1.155	Código: 6012060	Medidas: 4.000x1.210
					
Código: 6012059	Medidas: 4.000x1.150				

Otros modelos consultar

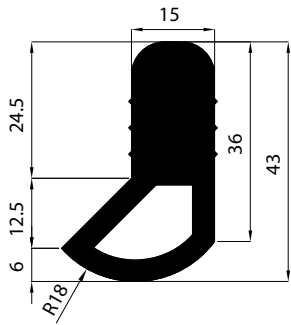

Código: 0002

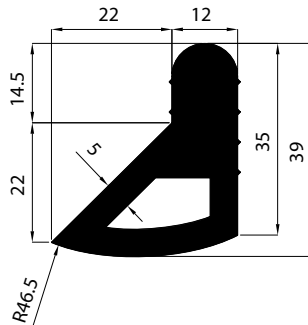

Código: 0003

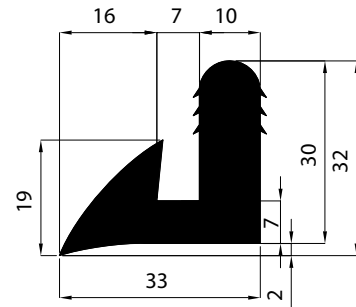

Código: 0007

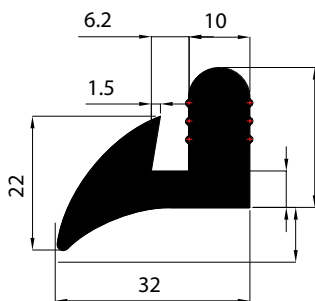

Código: 0010

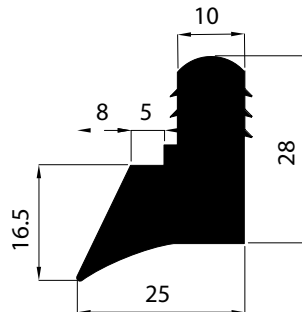

Código: 0011

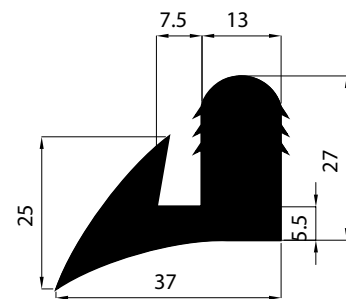

Código: 0021

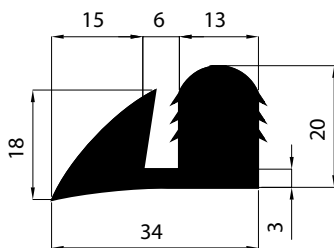

Código: 0025



Código: 0026

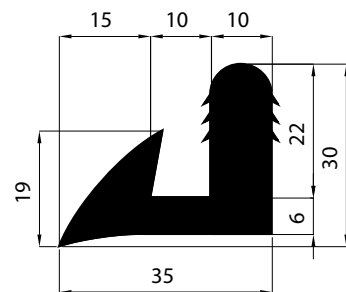

Código: 0028

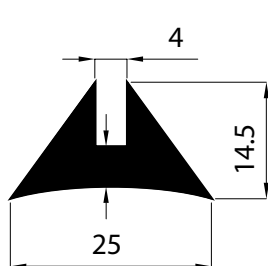

Código: 0031

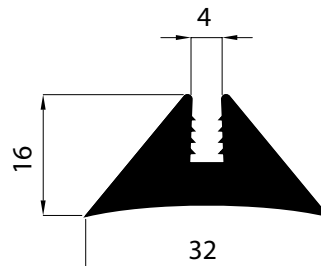

Código: 0032

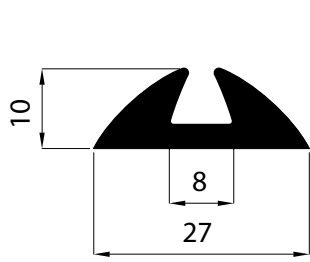

Código: 0033

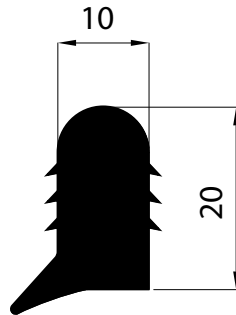

Código: 0037

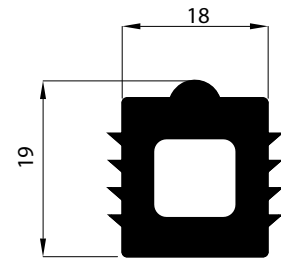

Código: 0057

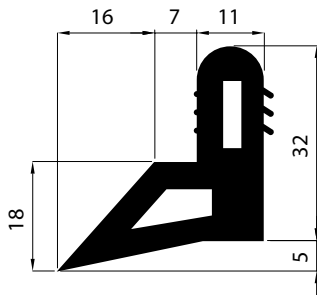

Código: 0089

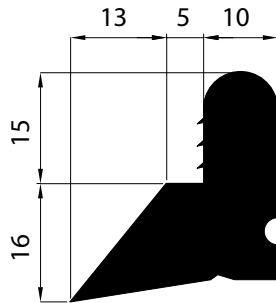

Código: 0096

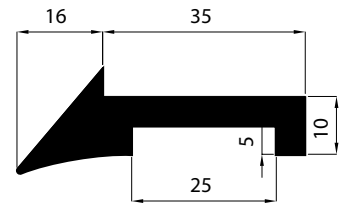

Código: 0518

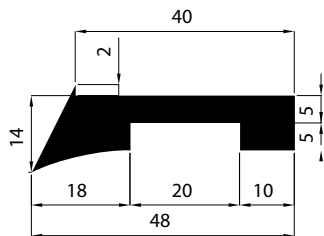

Código: 0529

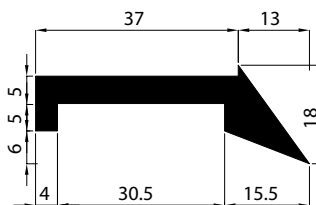

Código: 0603

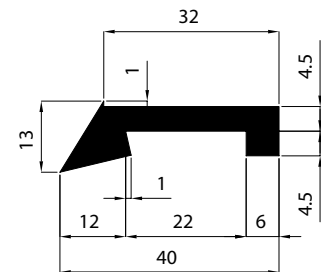

Código: 0604

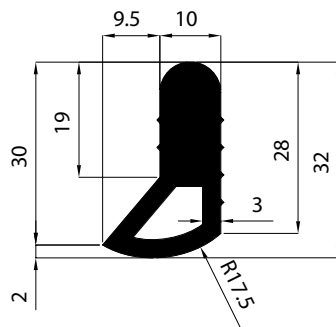

Código: 0788

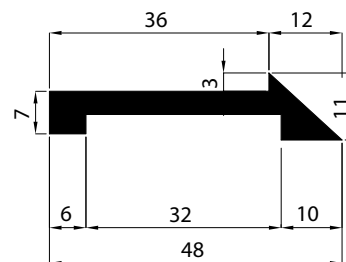

Código: 0861

Otros modelos consultar

Trifásico



Modelo	Momento (Kg/cm)	FC (Kg)	Potencia (KW)	Peso (Kg)
60	1.35	68	80	4.2
100	2.01	101	100	4.6
200	3.72	187	180	7.0
202	3.72	187	180	7.2
300	6.39	321	270	9.8
400	7.96	407	300	10.3
500	10.27	530	500	15.8
700	14.90	758	660	16.5
800	15.68	794	750	20.6
1.200	20.26	1.005	950	21.6
1.300	27.58	1.355	1.300	22.0
1.301	27.58	1.355	1.300	30.3
1.310	22.34	1.123	1.300	30.0
1.600	31.26	1.601	1.570	51.6
2.000	36.78	2.027	2.000	52.8
2.300	45.97	2.302	2.400	53.6
3.200	68.10	3.252	2.900	103.0
4.000	79.40	4.033	2.900	107.0
5.000	103.24	5.009	4.000	111.2
6.500	129.55	6.510	5.500	228.4
9.000	179.59	9.025	10.000	240.3

Monofásico



Modelo	Momento (Kg/cm)	FC (Kg)	Potencia (KW)	Peso (Kg)
60M	1.35	68	80	4.2
100M	2.01	101	100	4.6
200M	3.72	187	180	7.0
202M	3.72	187	180	7.2
300M	6.39	321	270	9.8

Neumático



Consultar modelos

De aguja



Consultar modelos

Navigia S.L.
Camino Cabecicos, 7b 30161 Llano de Brujas-Murcia

Tlf: +34 968 260022 / **Fax:** +34 968 263187 / **Mail:** navigia@navigia.es
www.navigia.es